

# 40" STAINLESS STEEL RGB MULTI COLOR LED SHOWERHEAD INSTALLTION INSTRUCTIONS



## BEFORE YOU BEGIN

Before installing, read entire Installation Instructions. Observe all local building and safety codes.

For the following installation instructions for your new product it is assumed that any old fixtures have been removed and any repairs or modifications to the water supply have been completed. Unpack and inspect the product for any shipping damages. If you find damages, do not install.

Contact Customer Service at 703-378-1915 / 800-684-4489. If you need assistance or have questions while installing your product, contact Customer Service.

We recommend consulting a professional if you are unfamiliar with installing bathroom fixtures.

## TOOLS REQUIRED\*



Plumber's Tape



Basin Wrench



Thread Sealant



Adjustable Wrench



Hex Wrench

\*not included

(head shower installation)  
decorative

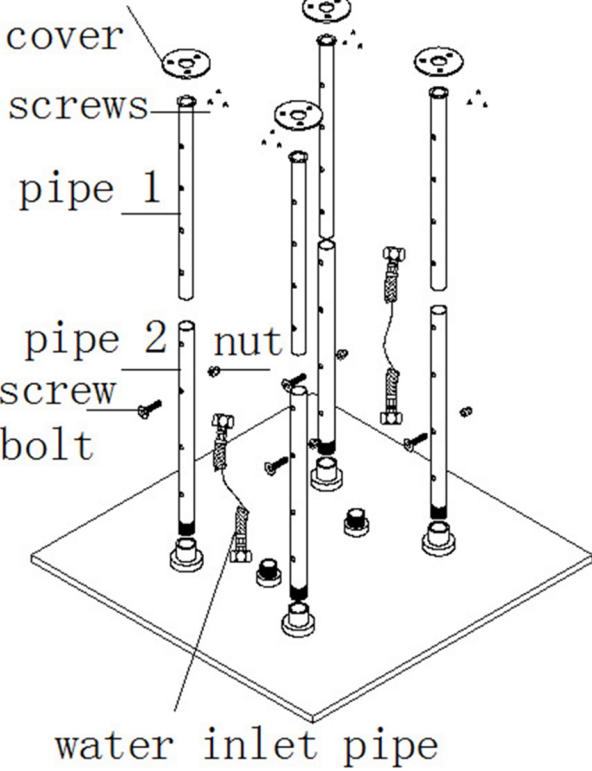

hole size on ceiling

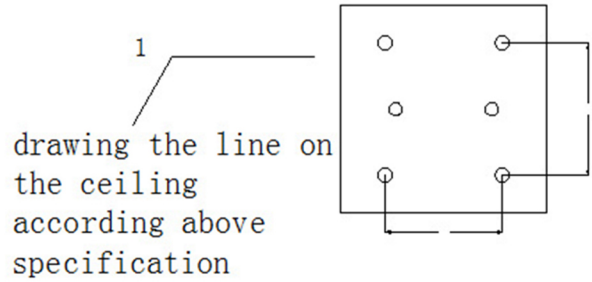

decorative cover

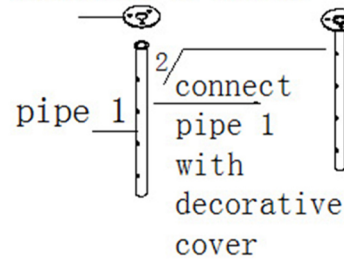

3  
Drill the holes on the ceiling according to above hole specification and install 4 pipes.

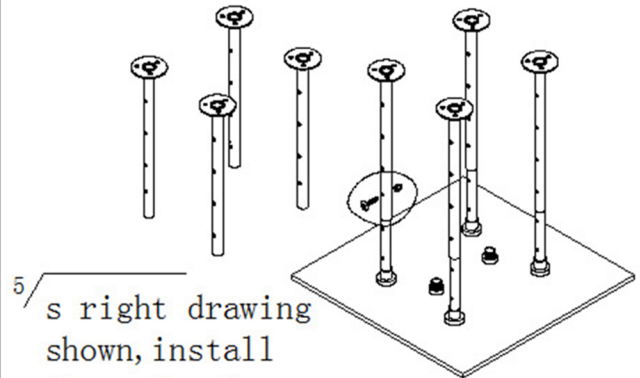
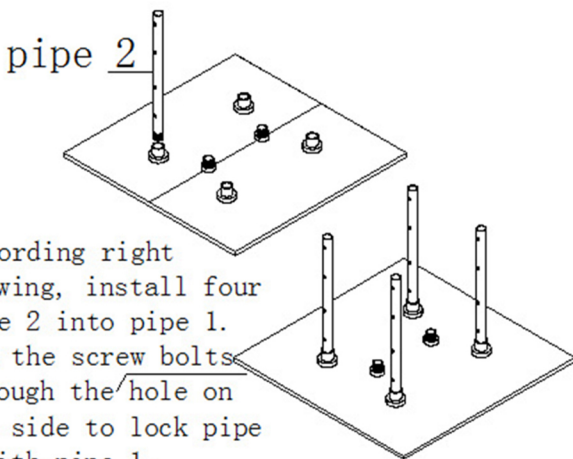

6  
After fix the shower head on ceiling, connect the shower hose with 2 water inlet on the shower head back cover. The other end connect with the water outlet pipe in the wall.

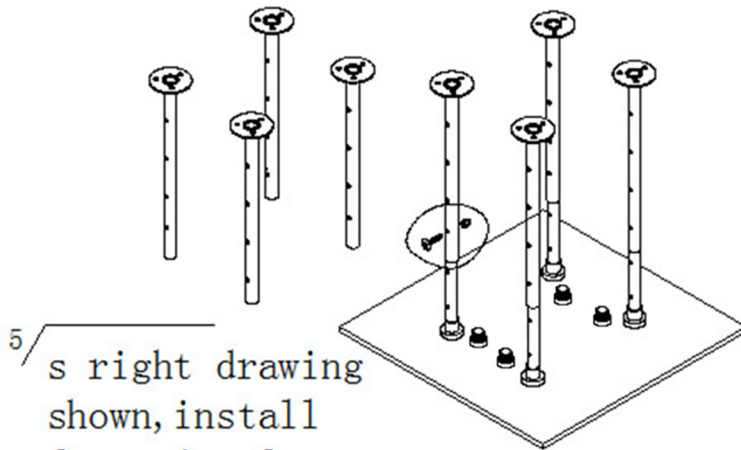

5/ s right drawing shown, install four pipe 2 on the head shower

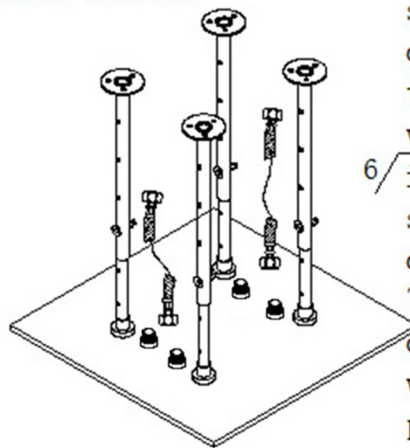

After fix the shower head on ceiling, connect the shower hose with 4 water inlet on the shower head back cover. The other end connect with the water outlet pipe in the wall.

6/



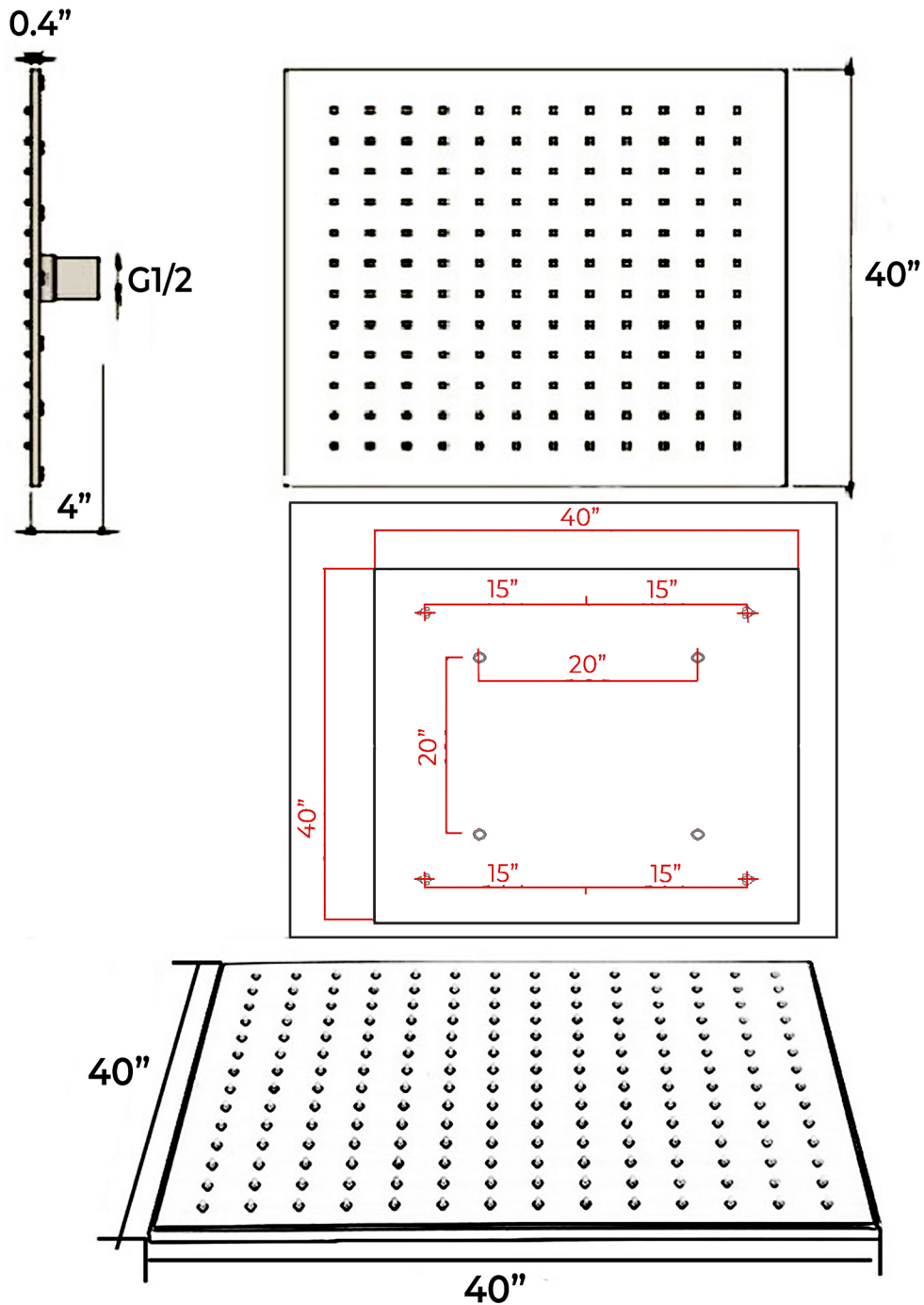

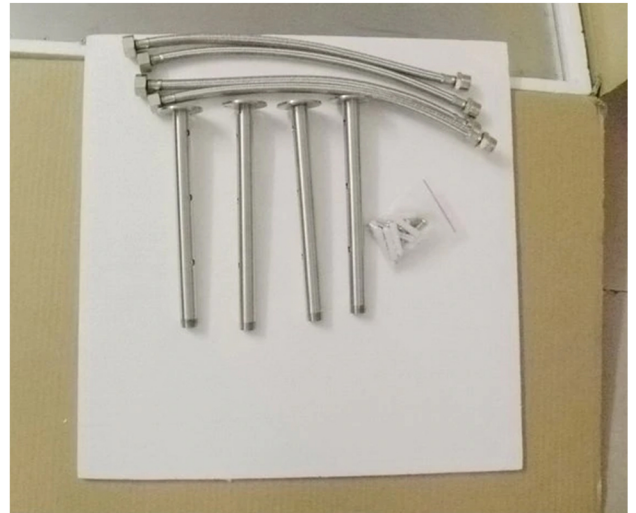
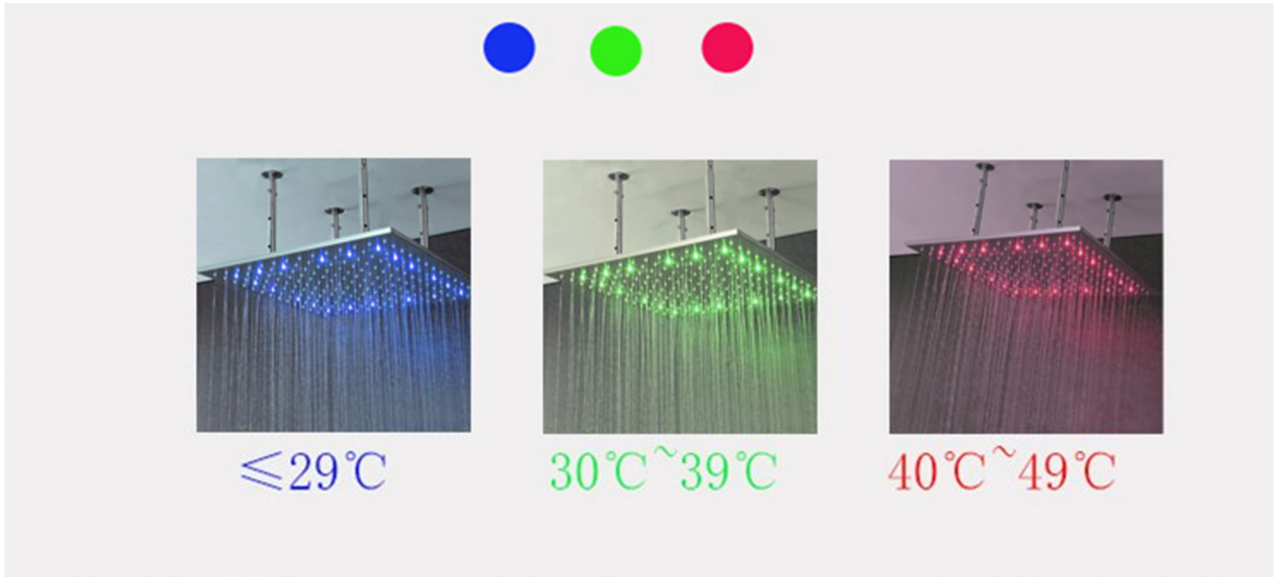

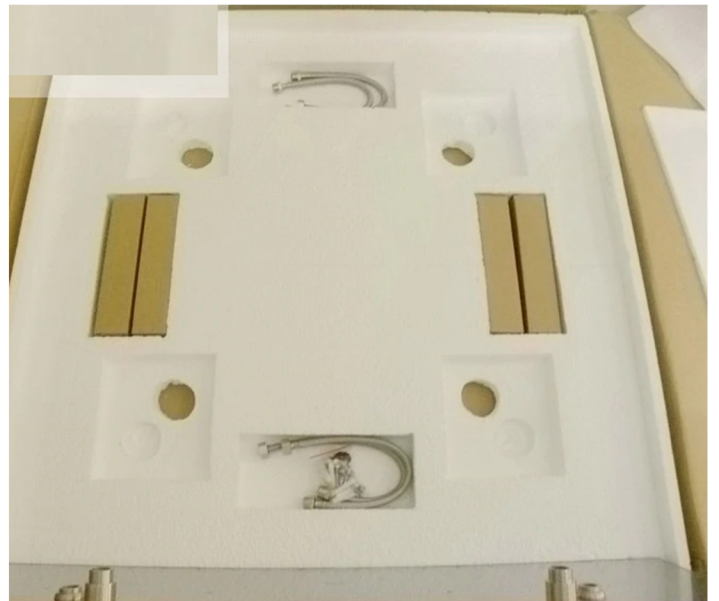
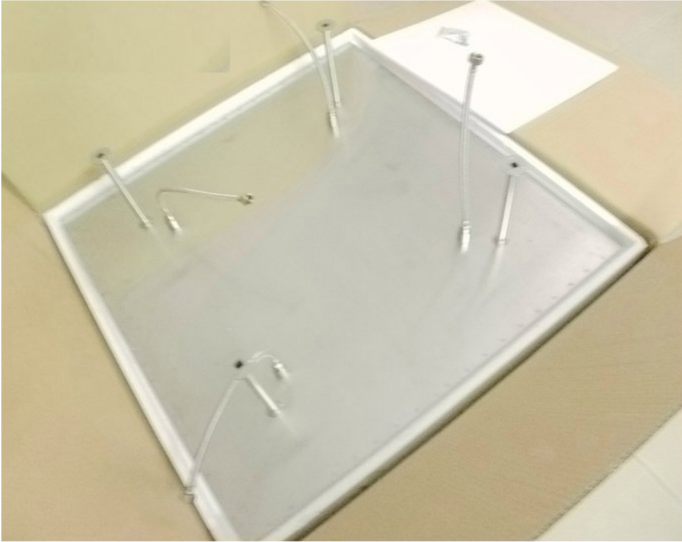

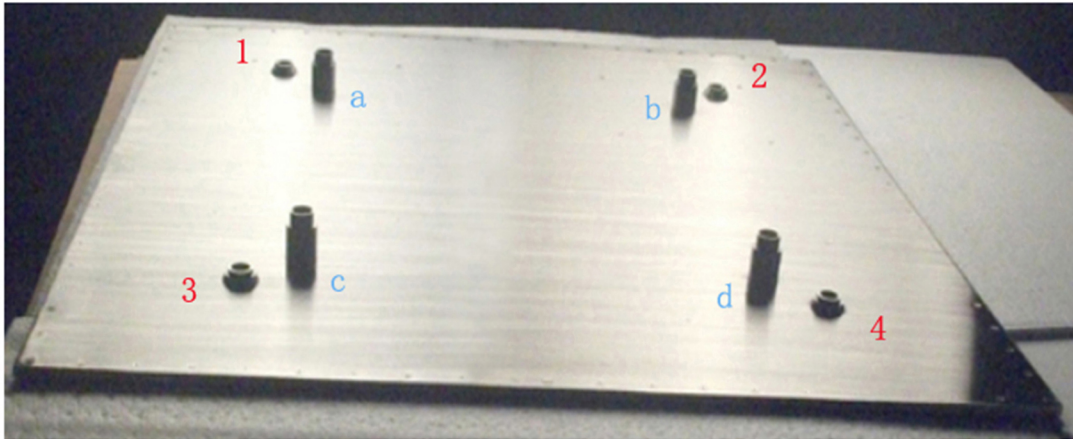

**4 Ceiling Arms Fixed Shower Head**

a.b.c.d. is shower hose G1/2" water inlet connect screws

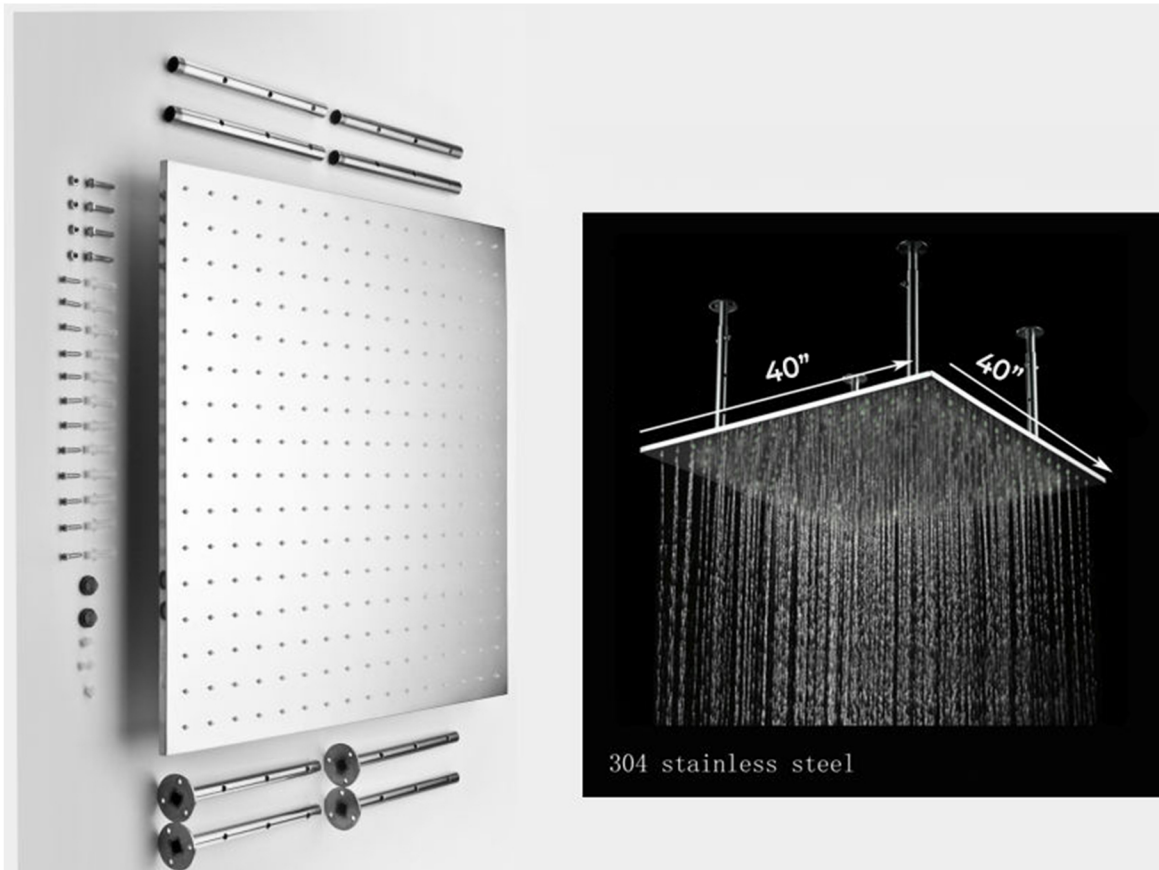

**40 inch biggest led light shower head  
304 stainless steel brushed surface  
ceiling mount led shower head**