

BEAUTIFUL CERAMIC ANTIQUE BRASS BATHROOM FAUCET W/ HAND-HELD SHOWER INSTALLTION INSTRUCTIONS



BEFORE YOU BEGIN

Before installing, read entire Installation Instructions. Observe all local building and safety codes.

For the following installation instructions for your new product it is assumed that any old fixtures have been removed and any repairs or modifications to the water supply have been completed. Unpack and inspect the product for any shipping damages. If you find damages, do not install.

Contact Customer Service at 703-378-1915. If you need assistance or have questions while installing your product, contact Customer Service.

We recommend consulting a professional if you are unfamiliar with installing bathroom fixtures.

TOOLS REQUIRED*



Plumber's Tape



Basin Wrench



Thread Sealant



Screwdriver



Adjustable Wrench



Hex Wrench

*not included

Weights & Dimensions



Hand Shower

Shower Head Diameter: 2.5 "
Hose Length: 59 "

Other Dimensions

Overall Faucet Height: 10.94 "
Faucet Spread Minimum: 7 "
Faucet Spread Maximum: 7 "
Spout Height: 4.19 "
Spout Reach: 7 "
Hole Diameter: 1.94 "
Overall Product Weight: 11.1 lb.

Parts:

Washer & Lock Nut	Copper Shank
	
2 Pcs	2 Pcs

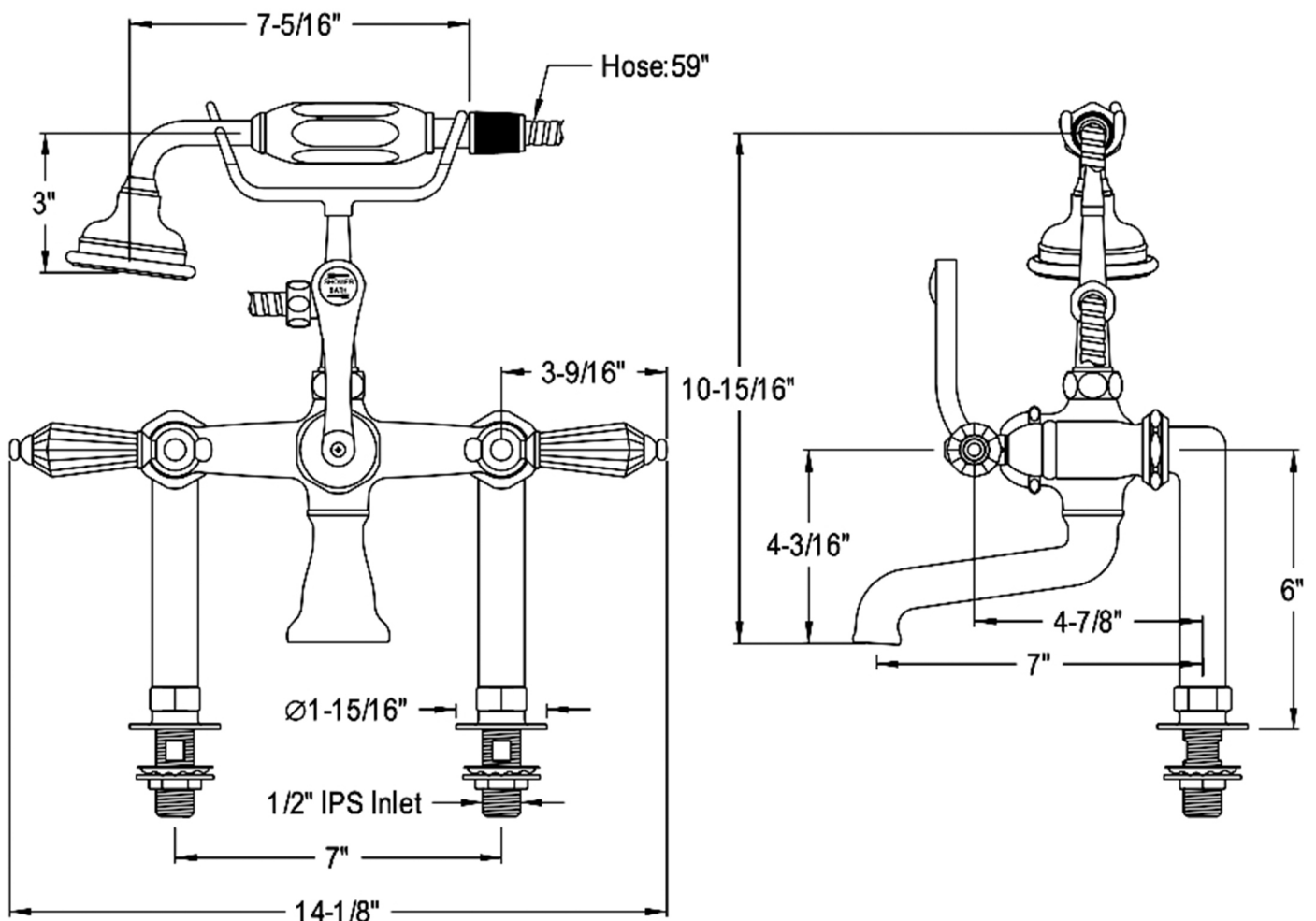

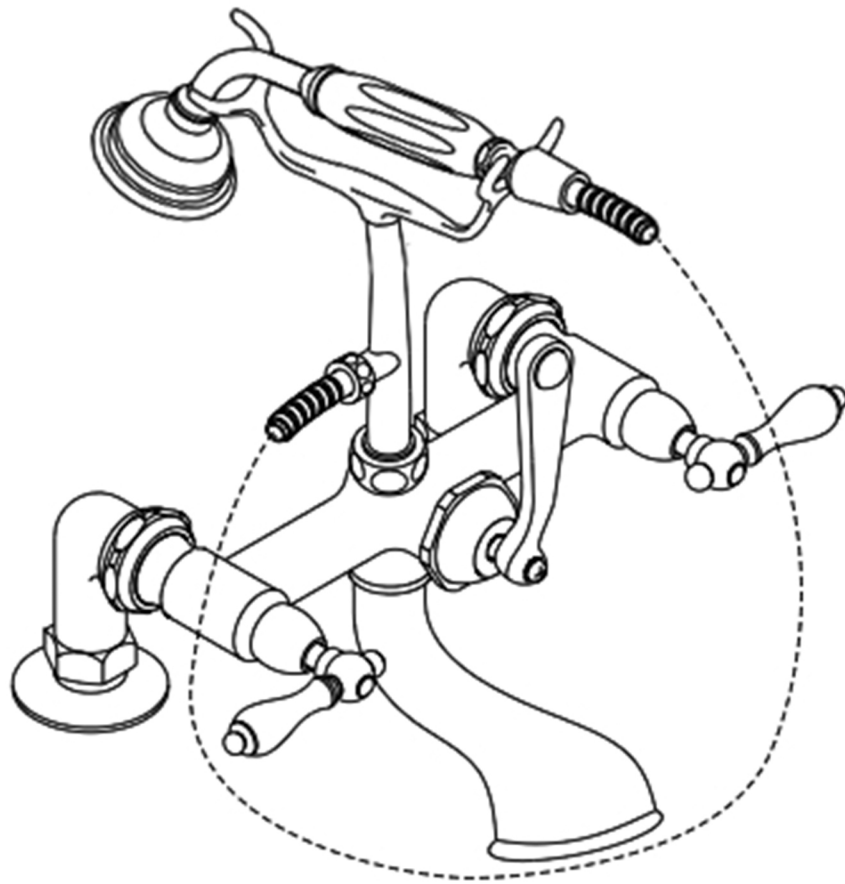

BEFORE BEGINNING INSTALLATION

1. Flush plumbing lines to clear any debris.
2. Shut off both supply lines after flushing.

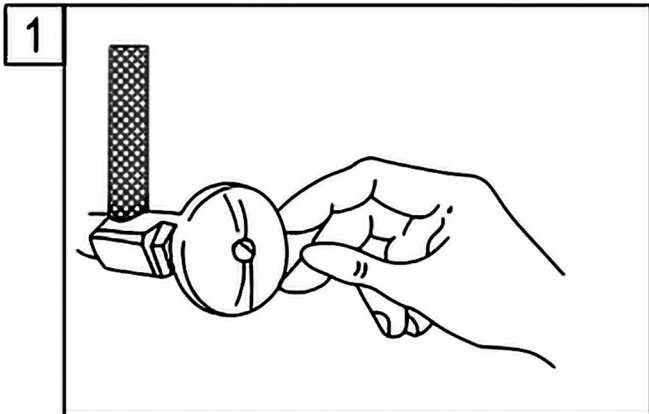

1. Shut off main water supply valve before installation.

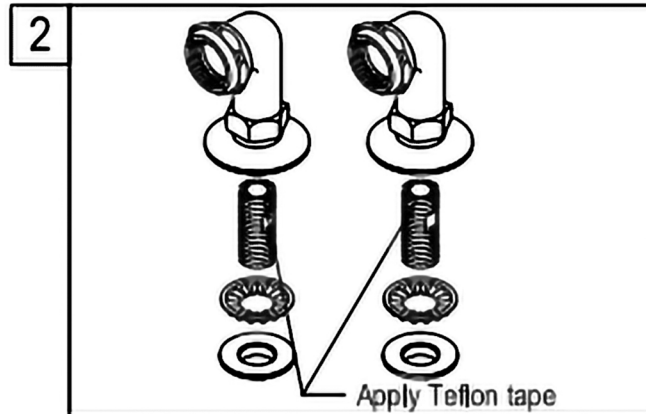

2. Apply Teflon tape on the threads of the copper shank. Install the elbow.

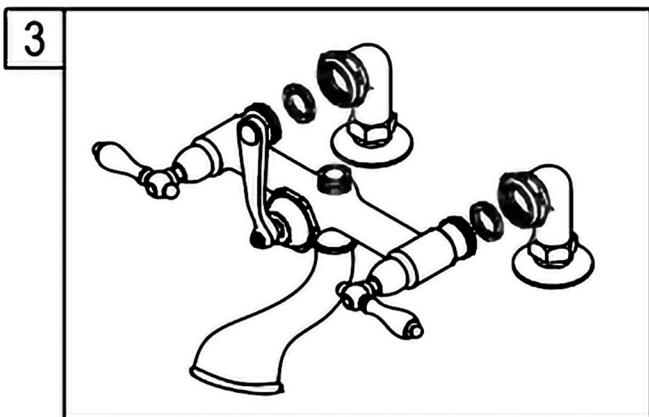

3. Before mounting the faucet onto supply elbows, apply small black washers onto both water inlets of faucet.

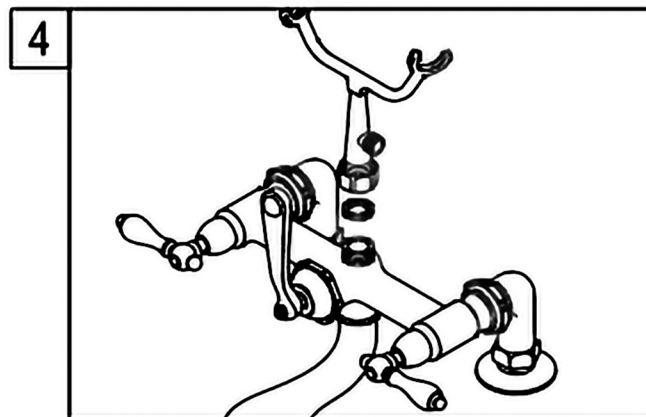

4. Install the shower cradle on top of faucet body.

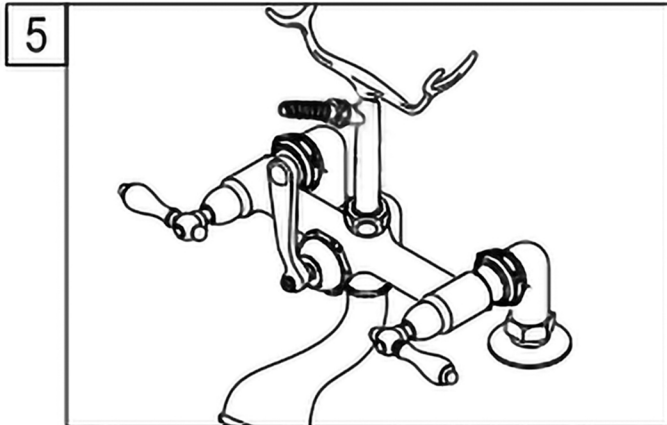

5. Place a washer between the side hole of the shower cradle and the cone nut of the shower hose. Tighten the cone nut.

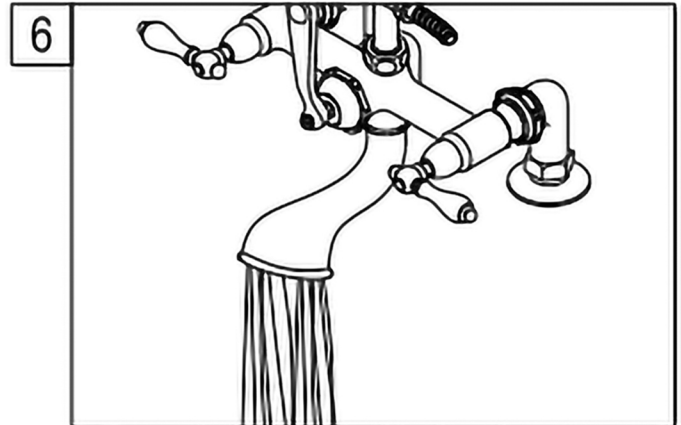

6. Turn on both hot and cold valves, let water run for at least one minute, this will clear any debris left in the line.

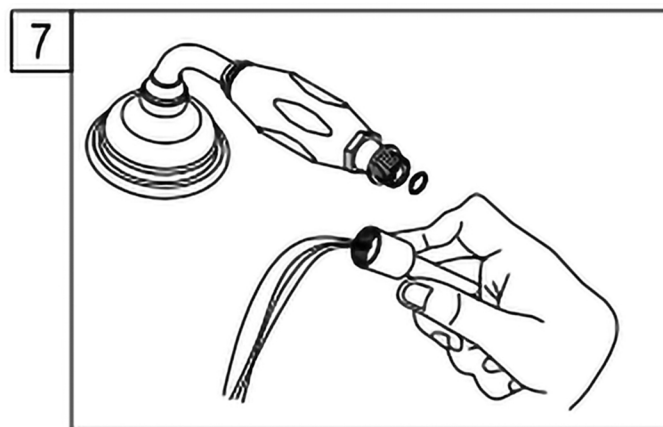

7. Remove shower by unscrewing the shower in a counter clockwise direction, turn on both hot and cold valves and let water run for at least one minute, this will clear any debris left in the line.

Parts:

Replacement Parts:

